

Operating Instrucitons

english

Elmasonic Xtra

Ultrasonic cleaning unit



Copyright © 2024 Elma Schmidbauer GmbH. All rights reserved.

Elma Schmidbauer GmbH

Gottlieb-Daimler-Strasse 17
78224 Singen (Germany)

AUTHORISED PARTNERS
TECHSPANGROUP

Techspan Australia Pty Limited

P O Box 1012, Mascot
N.S.W 1460
Australia

Ph: **1800 148 791**

Email: info@elma-ultrasonic.com.au

Website: www.elma-ultrasonic.com.au

Techspan New Zealand Limited

P O Box 15-262, New Lynn
Auckland 0600
New Zealand

Ph: **0800 603 603**

Email: info@elma-ultrasonic.co.nz

Website: www.elma-ultrasonic.co.nz

Technical support:

TECHSPANGROUP

Australia:

Tel: 1800 148 791

Email: info@elma-ultrasonic.com.au

New Zealand:

Tel: 0800 603 603

Email: info@elma-ultrasonic.co.nz

Subject to technical and visual modifications.

Contents

1 About this manual.....	4	9.1 Notes on installation site	15
1.1 User	4	9.2 Set up the unit	16
1.2 Other applicable documents	4	9.3 Connect the unit	16
1.3 CE mark.....	4	10 Filling the tank	16
2 Proper use	5	10.1 Dosing cleaning agent.....	17
2.1 Ultrasonic cleaning	5	10.2 Degassing the liquid	18
3 Safety	5	11 Insert objects to be cleaned	19
3.1 The structure of warnings	5	12 Operating the unit.....	19
3.2 Meaning of symbols on the unit.....	5	12.1 Set the cleaning duration.....	20
3.3 Meaning of symbols on the nameplate	6	12.2 Changing ultrasound mode	20
3.4 Safety information on specific types of hazard.....	6	12.3 Setting cleaning temperature	21
4 Use of cleaning agents.....	8	12.4 Starting/stopping ultrasonic cleaning	21
4.1 Permissible cleaning agents.....	8	12.5 Remove cleaned objects	22
4.2 Cleaning agents.....	8	13 Drain the unit.....	22
5 Technical data	9	14 Malfunctions/fault messages.....	23
5.1 Elmasonic Xtra 40, 60	9	14.1 Troubleshooting.....	23
5.2 Elmasonic Xtra 120, 180, 300	10	14.2 Fault messages	23
5.3 Elmasonic Xtra 40 - 300	11	15 Maintenance	25
6 Product contents	12	15.1 Replace the network cable	25
7 Unit description.....	13	15.2 Clean enclosure	25
8 Controls	14	15.3 Cleaning the tank	25
8.1 Operating modes	15	15.4 Disinfect.....	26
9 Setting up and connecting the unit.....	15	15.5 Clean the blower and check that it is working correctly (sizes 120 and up)	26
		16 Disposal.....	26

1 About this manual

NOTE Please read the manual before using the product. This manual forms part of the contents supplied with the unit. Keep the manual in an accessible place close to the product, and keep it with the product if it is sold on.

Meaning of the symbols used:

- This symbol denotes lists.
- ✓ This symbol denotes requirements.
- 1. Numbers with a dot denote actions.
- This symbol denotes individual actions.
- ⇒ This symbol denotes interim results.
- ➔ This symbol denotes the result of an action.
- 1 Numbers without a dot denote image labels.

1.1 User

In the manual, the term User refers to all persons who transport, set up, connect, operate and maintain the unit. The manual is aimed at persons with appropriate technical knowledge and experience in handling similar units.

The user is at least 16 years old. They must have read and understood the manual and be capable of following all notes and instructions.

All tasks that go beyond the pure operation of the unit within the scope described here must be performed by qualified and authorised specialists.

1.2 Other applicable documents

In addition to the specifications given in this manual, the following documents and directives also apply and may take precedence. This list is not exhaustive:

- Regional safety regulations and other locally applicable provisions.
- Safety data sheet and dosing instructions of the cleaning agents used.
- All serious incidents that occur in connection with the product must be reported to the manufacturer and the responsible authority of the member state in which the operator and/or the patient are resident.

1.3 CE mark

This unit fulfils CE marking requirements in line with EU-directives. Details are stated in the EU declaration of conformity that can be obtained from the manufacturer.

Technical changes to the unit must be approved by the manufacturer.

2 Proper use

2.1 Ultrasonic cleaning

Only use the product in line with the listed specifications.

Using the unit in any other way is considered improper use.

- The product is intended for ultrasonic cleaning of objects with liquids.
- Do not use flammable liquids.
- Do not clean living creatures or plants.
- The product is only suitable for use in rooms.
- The product is designed for liquids that do not produce any vapours harmful to humans. If such liquids are used, extra safety measures must be implemented e.g., personal protective equipment.
- The user is responsible for assessing the cleaning results.
- Only authorised, qualified personnel who are familiar with the manual may operate this product. Unauthorised persons, in particular children, must not use this product.
- Only use original accessories made for this product.

3 Safety

3.1 The structure of warnings



SIGNALWORD

Type and source of the danger

Possible consequences of the danger if disregarded.

➤ Measures to prevent the danger.

Signal word	Meaning	Consequences if disregarded
DANGER	Immediate danger	Death or serious injury
WARNING	Possible dangerous situation	Death or serious injury
CAUTION	Possible dangerous situation	Slight injuries, damage to components or units
NOTICE	Useful advice or tip	No risk of personal injury, but possible damage to components or units











Table 1: Meaning of the signal words

3.2 Meaning of symbols on the unit



Warning – hot surfaces, vapours and liquids

3.3 Meaning of symbols on the nameplate

	Attention
	Read the manual
	Manufacturer
	Date of production
	Order number
	Serial number
	CE mark
	UK Conformity Assessment marking
	cTUVus marking for Canada and USA
	Disposal information

3.4 Safety information on specific types of hazard

Electrical power

Contact with live components can lead to serious injury or death due to electrocution!

- Do not connect the unit to the power supply if the connection cables or other components are visibly damaged.
- Keep the enclosure and control elements clean and dry.
- Protect the unit against penetrating moisture.
- The mains voltage and the connected load on the nameplate must correspond to the on-site connection conditions.
- Only operate the unit in power circuits that are protected by a fault-current circuit breaker.

Risk of fire and explosion

Critical injuries, burns

- Do not fill the cleaning tank with flammable liquids.
- Only use cleaning agents that are approved for this unit.
- In case of doubt, ask the manufacturer or supplier.

Infections

Danger of possible infection due to poor cleaning results, dirty cleaning fluid and insufficient maintenance and disinfection of the unit.

- Change the cleaning fluid when it becomes visibly dirty and at least once per day.
- Clean the tank and surfaces thoroughly after draining the fluid and disinfect, if necessary.
- Check the cleaning results. The operator is responsible for monitoring the cleaning results.

Hot liquids and surfaces

Danger of burns and scalds due to contact with hot fluids or surfaces caused by high operating temperatures or continuous ultrasound operation.

- Do not touch the surfaces, accessories or objects being cleaned.
- Danger of splashes caused by high temperatures, by switching on ultrasound operation or by careless insertion of the basket or objects. If necessary, wear suitable protective equipment.
- If work must be performed on hot components, switch off the unit and allow to cool. If necessary, wear suitable protective equipment.

Cleaning agents

Volatile, corrosive or aggressive cleaning agents can cause chemical burns to the skin and respiratory tract.

- Observe the safety data sheet when using cleaning agents.
- Wear the protective equipment stipulated in the safety data sheet.
- Where necessary, provide adequate extraction for the emitted vapours and regularly check that the extraction system is working correctly.
- Observe the information stipulated in the *Cleaning agents* chapter. In case of doubt, ask the manufacturer or supplier.

Ultrasound-conductive liquids and materials

Ultrasound damages the cell membranes and bone structure.

- Do not reach into the ultrasonic bath during ultrasound operation.
- During ultrasound operation, do not touch any parts that conduct ultrasound, such as the tank, basket or any accessories used.

Ultrasound noise emissions

Working with ultrasonic cleaning units for longer periods of time can damage your hearing.

- Use the lid or wear personal ear protection when working on ultrasonic units.
- Pregnant women must not be subjected to the noise emissions for longer periods of time.
- Keep animals away from the vicinity of ultrasonic devices.

Electromagnetic radiation

- No binding statement can be made for persons with active medical implants, such as pacemakers or implanted defibrillators. A binding statement can only be made for specific workstations and in consultation with the implant manufacturer.

4 Use of cleaning agents

A cleaning agent can be added to the liquid in the tank to improve the cleaning results.

If using cleaning agents, observe and apply the instructions stated in the safety data sheet and product information.

Also observe the following information:

4.1 Permissible cleaning agents

- Only use aqueous cleaning agents for ultrasonic cleaning.
- Only use cleaning agents that are suitable for ultrasonic cleaning.

Elma provides a wide range of aqueous cleaning agents developed in-house that are optimised for ultrasonic cleaning.

A list of Elma cleaning agents can be found here:

<https://www.elma-ultrasonic.com/en/products/cleaning-chemistry>

4.2 Cleaning agents

Use of aggressive, corrosive cleaning agents:

Aggressive, corrosive cleaning agents can cause severe chemical burns if they come into contact with eyes or skin. Insufficient ventilation can result in severe chemical burns to the respiratory tract.

- Before using any cleaning agents, read the safety data sheet and product information and observe and apply the instructions.
- Where necessary, install an effective extractor system for the emitted vapours (e.g. at higher temperatures) and regularly check that the extractor system is working correctly.
- Never reach into the tank when filled with cleaning agent.
- Wear suitable protective equipment in line with the safety data sheet.

Danger of fire or explosion when using combustible cleaning agents

Ultrasound and heat increase the evaporation of liquids and form extremely fine mists that readily ignite on contact with sources of ignition. This can result in severe burns or death.

- Do not use cleaning agents that are labelled with the pictograms GHS01 (explosive), GHS02 (flammable) or GHS03 (oxidising) in line with the CLP regulation (EC no. 1272/2008). Do not use cleaning agents that have a flashpoint.
- If necessary, clarify the cleaning agents that can be used by consulting the manufacturer or supplier.



Table 2: GHS pictograms for explosive, flammable or oxidising substances

Damage to stainless-steel tank caused by unsuitable cleaning agents

Unsuitable cleaning agents can cause pitting and therefore damage the stainless-steel tank within a short time.

- Consult the unit and cleaning agent manufacturers to clarify whether the cleaning agent is suitable.
- Do not use any cleaning agents in the acidic pH range at the same time as halides, such as fluoride, chloride, bromide or iodide.
- Only use cleaning agents that are suitable for ultrasound applications.

5 Technical data

5.1 Elmasonic Xtra 40, 60

Elmasonic Xtra	Unit	40	60
Mechanical data			
Max. external dimensions W/D/H (unit with cover)	mm	435 / 215 / 320	500 / 215 / 320
Max. opening dimensions W/D	mm	235 / 135	300 / 135
Fill level (tank base to fill level marking)	mm	115	
Working height (basket base to fill level marking)	mm	85	
Interior dimensions of basket W/D/H (original accessories)	mm	195 / 105 / 95	255 / 105 / 95
Max. basket loading (original accessories)	kg	3,0	5,0
Total volume	L	5,0	6,3
Recommended tank operating capacity	L	4,0	5,1
Weight (unit with cover)	kg	6,8	7,9
Performance data			
Total power consumption	W	540	560
Ultrasonic power effective $\pm 10\%$	W	140	160
Ultrasonic peak performance max.	W	560	640
Heating power	W	400	

5.2 Elmasonic Xtra 120, 180, 300

Elmasonic Xtra	Unit	120	180	300
Mechanical data				
Max. external dimensions W/D/H (unit with cover)	mm	500 / 315 / 370	530 / 380 / 370	700 / 380 / 370
Max. opening dimensions W/D	mm	300 / 235	330 / 300	500 / 300
Fill level (tank base to fill level marking)	mm	155		
Working height (basket base to fill level marking)	mm	135		
Interior dimensions of basket W/D/H (original accessories)	mm	250 / 195 / 135	280 / 255 / 135	450 / 255 / 135
Max. basket loading (original accessories)	kg	7,0	8,0	10,0
Total volume	L	14,2	19,7	30,0
Recommended tank operating capacity	L	12,1	16,7	25,4
Weight (unit with cover)	kg	11,3	13,2	17,8
Performance data				
Total power consumption	W	1020	1260	1530
Ultrasonic power effective $\pm 10\%$	W	220	260	330
Ultrasonic peak performance max.	W	880	1040	1320
Heating power	W	800	1000	1200

5.3 Elmasonic Xtra 40 - 300

Elmasonic Xtra	Unit	40 - 300
Mechanical data		
Drain connection thread	Inches	1/2
Material (tank, enclosure)	–	Stainless steel
Electrical data		
Mains voltage $\pm 10\%$	V~	220 - 240 / 115 - 120
Mains frequency	Hz	50 / 60
Ultrasonic frequency -2.5 / +5.5	kHz	37
Max. target temperature 30 – 80	°C	80 (Temperature tolerance max. from -5 - +8)
Degree of protection	–	IP 20
Protection class	–	I
Ambient conditions		
Temperature (transport)	°C	-15 - +60
Temperature (operation, storage)	°C	+5 - +40
Air pressure (transport, storage)	hPa	500 - 1010
Permissible relative humidity (transport,	% r. h.	10 – 80, non-condensing
Permissible relative humidity (operation)	% r. h.	80; non-condensing under fluctuating temperatures
Max. perm. altitude (operation)	m above sea level	+2000
Overvoltage category	–	II
Degree of contamination	–	2
Sound pressure level LpAU*	dB	< 80

*Measured sound pressure level with cover at a distance of 1 m.

6 Product contents

NOTE	<p>Check delivery for damage to the packaging. Document any damage immediately (e.g. photo), and report it to the manufacturer or dealer.</p> <p>Check that all parts of the delivery are complete and undamaged.</p> <p>Never put a damaged unit into operation.</p> <p>Dispose of packaging materials that are no longer required in an environmentally friendly manner.</p>
-------------	--



Illustration 1: Product contents

1	Ultrasonic unit
2	Cover (Stainless steel)
3	Network cable
4	Manual (not shown)

7 Unit description



Illustration 2: Operating side

- 1 Handle
- 2 Ball valve (on/off) for Drain
- 3 Feet, non-slip
- 4 Controls
- 5 QR-Code, View and download manuals (suitable for Android & IOS-Systems)
- 6 Warning of hot surfaces
- 7 Mains connection (not shown)
- 8 Nameplate (not shown)
- 9 Blower on the unit base, not shown (from size 120)

8 Controls

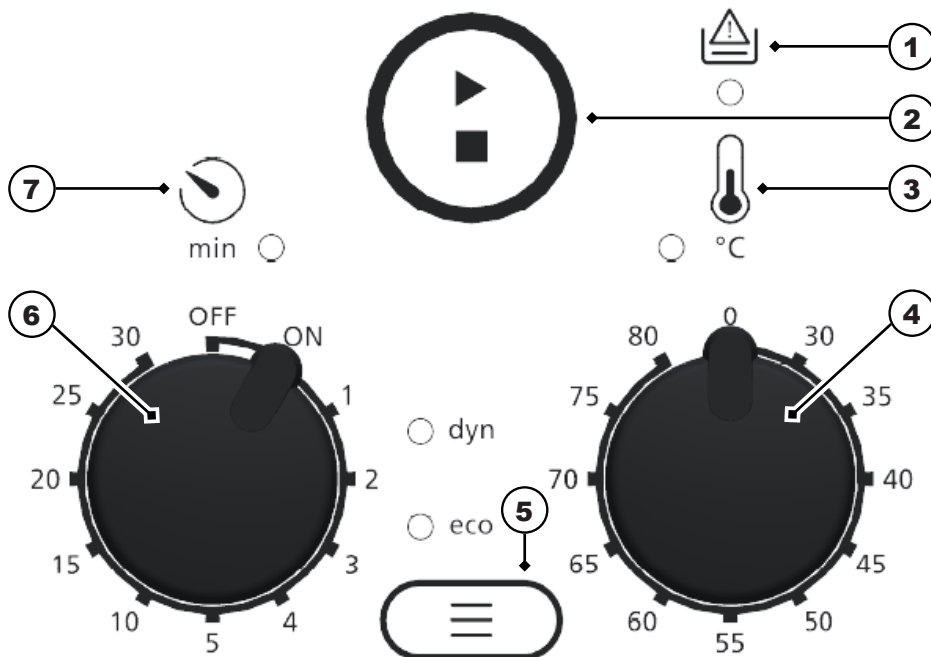

Illustration 3: Controls

- 1 **Dry-running LED indicator**, dry-running detection is available when the heating is switched on,
flashes white and an **acoustic signal tone** indicates that the liquid in the tank is too low or empty (see Chapter Fault messages [► 23]).
- 2 **Start/Stop button**, switch ultrasonic cleaning on/off
- 3 **LED indicator for temperature**
Flashes green – while in heating mode to reach the set temperature. The heating is on.
Lights up green – once the set temperature is reached. The heating switches off once the set temperature is reached.
Flashes red or orange – there is a fault (see Chapter Fault messages [► 23]).
- 4 **Rotary knob for temperature 0 - 80 °C**
The temperature of the cleaning liquid can be set from **30 - 80 °C** in **5 °C** increments.
0 = Heating off
- 5 **Mode button**, set the **dyn** (dynamic) or **eco** ultrasound mode;
the LED indicator of the current ultrasound mode lights up.
- 6 **Cleaning duration rotary knob**
ON/OFF, switch the unit on/off;
set a cleaning duration of 1, 2, 3, 4, 5, 10, 15, 20, 25 or 30 minutes.
- 7 **LED indicator for cleaning duration;**
flashes green – for the duration of ultrasonic cleaning,
lights up green – when ultrasonic cleaning is complete,
flashes red – there is a fault, see Chapter Fault messages [► 23].
Acoustic signal tone – indicates that the cleaning duration has ended.

8.1 Operating modes

Operating mode	Description
Switched off	The cleaning duration rotary knob is turned to OFF . All LEDs are off.
Switched on	The cleaning duration rotary knob is turned to ON , or a cleaning duration of 1–30 minutes is set. The LED of the set ultrasound mode lights up.
Safety switch-off with wake-up function	The unit is switched on. Automatic safety switch-off occurs after 8 hours of inactivity or in case of a brief interruption of the power supply. The LEDs turn off. The unit can be switched on again by pressing a button or turning the rotary knob.
Ultrasonic cleaning	Ultrasonic cleaning was started by pressing the Start/Stop button. The LED for cleaning duration flashes during ultrasonic cleaning. You can press Start/Stop again to terminate ultrasonic cleaning at any time. The LED for cleaning duration is off.
Ultrasonic cleaning complete	A brief audible signal is emitted at the end of the cleaning duration. The LED for cleaning duration lights up .

9 Setting up and connecting the unit

9.1 Notes on installation site

The unit is designed to be set up in commercially used premises such as laboratories, medical practices, etc.

- The installation site must be well ventilated.
 - The permissible ambient conditions are met.
 - The unit must be installed on a sturdy, horizontal, non-slip, moisture-resistant work surface with the following characteristics:
 - The surface must be non-flammable.
 - There must be sufficient clearance above the unit to allow the cover and the objects being cleaned to be removed.
 - There must be an area available next to the unit for setting down the basket and inserts.
 - Electrical connection conditions:
 - Splash-proof earthed socket near the unit (cable length approx. 1.5 m).
 - The power connection must be protected by a fault-current circuit breaker (RCD).
 - Ensure that the power supply required to operate the unit is available.
 - Wastewater connection requirements:
 - **Units without drains:** select an installation site located close to a sink that can be used to empty the unit.
 - **Units with drains:** properly connect the unit drain to the on-site wastewater disposal system. If necessary, properly route the drain into a sink located nearby.
- ⚠ CAUTION! Use heat-resistant material.**

9.2 Set up the unit

- ✓ Unpack the unit completely.
- ✓ Keep the cover and accessories e.g., basket, inserts, etc., on hand.
 - Place the unit on the selected surface.
IMPORTANT The controls, such as the display, buttons and, if applicable, discharge tap must be clearly visible and easily accessible.
- ➔ The unit has been set up.

9.3 Connect the unit

Connecting the drain

- ✓ Collect the required connection materials, e.g., suitable heat-resistant hose, hose nipple and hose clip (not included with the product contents).
 1. Screw the hose nipple into the drain ball valve.
 2. Push the hose onto the plug nipple and secure it with a hose clip.
 3. Connect the hose to the wastewater disposal system. If necessary, properly route the hose into a sink.
 4. Check the drain for leaks. To do so, fill the tank with cold water up to around 1/3 of the fill level. Then, open the discharge tap to check all connections for leaks.
 5. Seal any leaks found.
- ➔ The drain is connected.

Connecting the power cord

- ✓ Ensure that the required power connection is available.
 1. Plug the power cord into the IEC connector on the unit.
 2. Route the power cord in such a way that it does not pose a tripping hazard, cannot be damaged and is not exposed to moisture. The power cord must not touch the unit housing, as the housing becomes hot during operation.
 3. Connect the plug. The plug must be easily accessible so that it can be disconnected in emergencies.
- ➔ The power supply has been connected.

10 Filling the tank

Suitable cleaning liquids for ultrasonic cleaning are:

- Water
- Softened water
- Distilled water

Cleaning performance can be improved by adding aqueous cleaning agents. See Dosing cleaning agent.

- ✓ The unit and the tank are clean and, if necessary, disinfected.
- ✓ The recommended tank operating capacity for the unit sizes is stated in the technical data. See .
- ✓ The unit is ready to use.
- ✓ The drain ball valve is closed [2].
 1. Add the fluid to the tank up to the fill level marking (1) using, for example, a measuring jug.
⚠ CAUTION! An overfilled tank can cause the cleaning fluid to boil over at high temperatures.

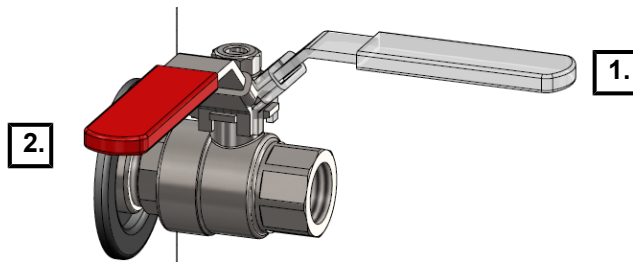

Illustration 4: Drain ball valve 1. open/2. closed

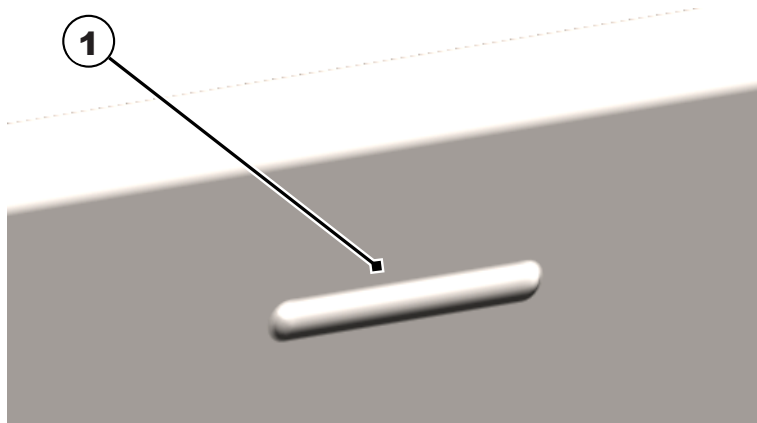

Illustration 5: Fill-level marking

2. The process of adding cleaning agents is explained in chapter Dosing cleaning agent.
 3. Fresh liquid must be degassed approx. 10 minutes prior to ultrasonic cleaning. See Degassing the liquid [► 18].
- IMPORTANT!** It is important to degas fresh ultrasonic cleaning baths to remove any air bubbles and dissolved gases that may be present in the cleaning liquid. Failure to remove these gases negatively impacts the cleaning result.

⇒ The tank has been filled.

Inserting a basket:

1. Hang the basket filled with the items to be cleaned in the tank.
IMPORTANT! The fill level in the tank will increase once the basket or insert is placed inside. This may cause the tank to overflow in the case of full baskets or dosages > 5%. To avoid this, do not fill the tank right up to the fill level marking in such cases until after the basket has been inserted.
 2. **IMPORTANT!** The objects being cleaned must be completely submerged in the fluid to achieve good cleaning results. If necessary, reduce the number of objects being cleaned.
- ➔ The tank is full, cleaning agent has been dosed (if necessary), liquid has been degassed and the basket has been inserted. Ultrasonic cleaning can be started.

10.1 Dosing cleaning agent

Cleaning performance can be improved by adding aqueous cleaning agents.

⚠ WARNING! Please follow the safety and operating instructions and observe the mixing ratio for the cleaning agent used!

Dosing information for the different unit sizes and typical volume concentrations are shown in the following table.

Unit size	Tank operating capacity	Dosing quantities in ml for following concentrations:			
		1%	2%	3%	5%
Volume concentration in %		1%	2%	3%	5%
	1 l/1000 ml	10 ml	20 ml	30 ml	50 ml
ES Xtra 40H	2.9 l	29 ml	58 ml	87 ml	145 ml
ES Xtra 60H	4.3 l	43 ml	86 ml	129 ml	215 ml
ES Xtra 120H	10 l	100 ml	200 ml	300 ml	500 ml
ES Xtra 180H	14.2 l	142 ml	284 ml	426 ml	710 ml
ES Xtra 300H	22 l	220 ml	440 ml	660 ml	1.1 l

- ✓ The aqueous cleaning agent is chosen based on the type of cleaning to be done.
 - ⚠ **WARNING! Do not use flammable cleaning agents!** See Use of cleaning agents [▶ 8].
- ✓ The unit is filled with liquid (e.g. water) up to the recommended tank operating capacity. See Fill the tank.
 1. Find the dosing quantity for the required concentration in the table and add the liquid to the unit.
 2. Stir the cleaning liquid to mix. The mixing effect of stirring is also achieved by degassing the cleaning liquid. See Degassing the liquid [▶ 18].
- ➔ The cleaning agent is dosed into the liquid. For further steps, see Fill the tank.

10.2 Degassing the liquid

Degassing of the liquid results in the following advantageous ultrasound effects:

- Improves the cleaning effect of the ultrasound.
- Stabilises the cleaning process.
- Ensures optimal mixing of the cleaning liquid.
- Improves the spatial temperature distribution in the liquid.

Procedure

- ✓ The unit is ready to use.
- ✓ Fresh liquid has been added to the tank.
- ✓ Cleaning agent has been added to the liquid, if applicable.
- ✓ The basket with the objects to be cleaned is not inserted.
 - i NOTE! Always degas the liquid without the basket and objects.**
 - 1. Set the cleaning duration to 10 minutes. See Set the cleaning duration [▶ 20].
 - 2. Start ultrasound mode *dyn* (dynamic). See Changing ultrasound mode [▶ 20].
 - i NOTE! Degassing can also be carried out with another ultrasound mode if the unit does not have the dyn ultrasound mode.**
 - ⇒ Let the unit run for at least 10 minutes in the set ultrasound mode.
- ➔ The liquid has been degassed.

11 Insert objects to be cleaned

- ✓ Ensure that all optional original accessories e.g., baskets and inserts for holding the objects being cleaned, are available.

IMPORTANT! Do not place objects on the bottom of the tank. The tank and the objects can be damaged by the ultrasonic operation.

1. Position the basket or insert next to the unit.
2. Place the objects inside the basket or insert without overfilling it. Arrange the objects to be cleaned in such a way that fluid can circulate freely around them.

IMPORTANT! Only clean objects that are suitable for ultrasonic operation, the set temperature and, where applicable, the cleaning agent in use. In case of doubt, contact the manufacturer or retailer.

3. Hook the filled basket or insert inside the tank.
- ➔ The objects being cleaned have been inserted.

12 Operating the unit

WARNING

Damage caused by noise emissions

Hearing damage!



- When working with the unit in ultrasound mode, cover it with the lid or wear hearing protection.
- Pregnant women must not spend long periods of time near an ultrasonic unit in operation.
- Keep animals away from the ultrasonic unit.

CAUTION

Hot liquid, vapours and unit parts!

Burns or scalds.



- Do not reach into the tank.
- When working at high cleaning temperatures (> 50 °C), only touch baskets, covers and inserts wearing suitable protective gloves or allow them to cool before touching them.

CAUTION

Dry running!

Damage to the tank and unit.



- Always fill the tank with fluid up to the fill level marking before operating the unit.
- Never operate the unit without cleaning fluid.
- Regularly monitor the filling level.

There are two options for setting the cleaning duration for ultrasonic cleaning:

- **Ultrasonic cleaning in continuous operation, cleaning duration rotary knob ON:**

Ultrasonic cleaning can be started or stopped at any time by pressing the **Start/Stop button**.

Important! In the **ON** (continuous operation) rotary knob position, the cleaning duration automatically stops after a maximum of 6 hours.

- **Timed ultrasonic cleaning operation, cleaning duration rotary knob 1–30 minutes:**

Ultrasonic cleaning stops automatically after the set time or at any time by pressing the **Start/Stop button**.

12.1 Set the cleaning duration

- ✓ The unit is ready to use.
- ✓ The unit is filled with liquid.
- ✓ The cleaning agent has been metered and added, if applicable.
- ✓ The liquid is degassed.
- ✓ The objects to be cleaned have been inserted.
- ✓ The unit is covered with the cover.

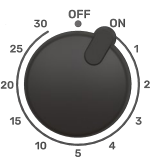

Turn the cleaning duration **rotary knob** to **ON** to switch on the unit for up to 6 hours.

Alternatively, turn the cleaning duration **rotary knob** directly to a time of 1, 2, 3, 4, 5, 10, 15, 20, 25 or 30 minutes to switch on the unit for a specific cleaning duration.

dyn

The LED indicator of the ultrasound mode ready for operation lights up.

eco



The heating system begins heating up the cleaning liquid if a temperature is set. The LED indicator for heating flashes green.

The LED indicator for heating is off if a temperature is not set. The temperature rotary knob is set to 0.



The cleaning duration is set. The cleaning duration stops automatically after the set time.

12.2 Changing ultrasound mode

Dyn (dynamic) Used for more intensive cleaning with greater cleaning power.

eco Used for gentle cleaning and quieter operation.

- ✓ The cleaning duration is set.



Press the **Mode button** to change the ultrasound mode.

dyn

The LED indicator of the set ultrasound mode lights up.

eco



The ultrasound mode has been changed.

12.3 Setting cleaning temperature

For units without heating, go directly to Chapter Starting/stopping ultrasonic cleaning [▶ 21].

- ✓ The cleaning duration is set.
- ✓ The required ultrasound mode is set.

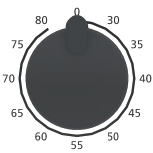

Turn the temperature **rotary knob** to the required temperature to set the cleaning temperature. The temperature can be set from 30–80 °C in 5 °C increments. The heating system immediately begins heating up the liquid.



The LED indicator for temperature flashes green until the set temperature is reached. Heating is on.

The LED indicator for temperature lights up green as soon as the set temperature is reached. Heating is off.

For even heating of the cleaning liquid, we recommend switching on ultrasonic operation during the heating process.

⚠ CAUTION! Especially in continuous operation, the ultrasonic operation serves to help heat the cleaning liquid in addition to heating mode!

Alternatively, stir the cleaning liquid occasionally to achieve even heating.



The cleaning liquid is heated up.
Ultrasonic cleaning can occur at the required temperature.

12.4 Starting/stopping ultrasonic cleaning

The cleaning liquid also heats up in ultrasonic operation without heating. Especially during continuous operation, the cleaning liquid can become hot due to ultrasonic operation.

- ✓ The cleaning duration is set.
- ✓ The ultrasound mode has been changed, if applicable.
- ✓ The cleaning temperature is set (for units with heating).



Press the **Start/Stop button** to begin ultrasonic cleaning. Ultrasonic cleaning stops automatically after the set time.



The LED indicator for cleaning duration flashes green during ultrasonic cleaning.

The LED indicator for cleaning duration lights up green when ultrasonic cleaning is complete. A brief audible signal tone also alerts you to the end of cleaning.



Press the **Start/Stop button** again to stop ultrasonic cleaning before the end of the set cleaning duration. The LED indicator for cleaning duration will go out.

Important! Check the temperature of the cleaning liquid regularly, especially when cleaning sensitive objects.

If the cleaning temperature is too high, allow the cleaning liquid to cool down or replace the cleaning liquid.



Ultrasonic cleaning is complete. Check the cleaning result.

i NOTE! Automatic safety shut-off is activated after 8 hours of unit inactivity. The LEDs turn off. The unit can be switched on again by pressing a button or turning a rotary knob.

12.5 Remove cleaned objects

- ✓ The end of ultrasonic cleaning is indicated by the “End of cleaning” symbol or, where applicable, an acoustic signal.
- 1. Carefully remove the lid, and allow any dripping water to drip into the tank.
 - ⚠ **CAUTION!** If using high cleaning temperatures > 50 °C, allow the liquid to cool down first or use suitable heat-insulating protective gloves.
- 2. Lift the basket or insert out of the tank, allow the excess fluid to drain briefly, and place it on a drain board.
 - ⇒ The objects are now clean. Check the cleaning result.
- Check the fill level if you intend to start another ultrasonic cleaning process.
- Switch off the unit. If the fluid is dirty or will not be used again, empty out the liquid. See the section Draining the unit for information.

13 Drain the unit

CAUTION



Hot liquids

Danger of burns and scalds caused by spilled fluid!

- Do not move or carry the unit when full of liquid.
- **The exception** to this are small units without a drain. Allow the liquid to cool down before emptying and disconnect the mains plug.

Emptying units with drains:

- ✓ Ultrasound operation has finished.
 - ✓ The basket or insert has been removed.
 - ✓ The drain is connected to an on-site wastewater disposal system.
1. Open the drain ball valve to drain the liquid.

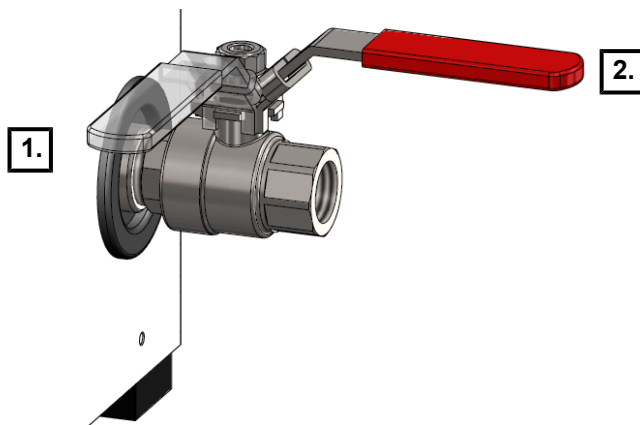

Illustration 6: Drain ball valve (1. closed/2. open)

2. Clean and, if necessary, disinfect the tank. See Chapter Maintenance [► 25].

⚠ CAUTION! Never submerge the unit in water.

3. Close the drain ball valve when the tank is empty.

➔ The unit is emptied, cleaned and, if necessary, disinfected.

14 Malfunctions/fault messages





14.1 Troubleshooting

Fault	Possible cause	Resolution
No LEDs are lit	Unit is not switched on, safety switch-off has been triggered or there is no power supply	<ul style="list-style-type: none"> • Turn rotary knob or press button • Switch on the unit • Check that the power cable is correctly connected and undamaged; replace if necessary • Check power supply
Buttons/rotary switches indicate no function	Controls defective	<ul style="list-style-type: none"> • Contact the manufacturer.
Ultrasonic operation does not start	Ultrasonic unit defective	<ul style="list-style-type: none"> • Contact the manufacturer.
Cleaning liquid does not heat up (applies for units with heating)	Heating defective	<ul style="list-style-type: none"> • Contact the manufacturer.

14.2 Fault messages

If a fault occurs, various different flashing patterns indicate the fault type. Ultrasonic operation always switches off if a fault occurs.

LED	Flashing pattern	Fault type	Possible remedies
	Flashes red twice, pauses, repeats	Power supply faulty	Connect the unit to a socket of a different power circuit

LED	Flashing pattern	Fault type	Possible remedies
	Flashes red three times, pauses, repeats	Ultrasonic performance faulty (too high or too low)	Switch unit off, switch on again after 1 minute and restart cleaning Increase or decrease liquid level, if necessary
	Continuously flashes red	All other faults	Contact service centre or manufacturer
	Continuously flashes orange (applies for units with heating)	Max. temperature > 90 °C reached	Switch unit off and allow the cleaning liquid to cool down, disconnect unit from the mains if necessary
	Continuously flashes red (applies for units with heating)	Faulty temperature sensor	Contact service centre or manufacturer
	Short signal tone – flashes white – continuous (for units with heating)	Fill level too low or empty (dry running detected)	Switch off the unit; top up with liquid; switch on the unit again; If the LED continues to flash, have the heating repaired

Contact the service centre or the manufacturer in the following cases:

- The measures described here do not remedy the fault.
- The fault recurs (repeatedly), even after performing the following measures:
 - The unit was disconnected from the mains and plugged in again about 1 minute later, and cleaning was restarted.
- The unit must be repaired at the factory.

IMPORTANT Empty the unit completely and clean and disinfect it thoroughly before sending it for repair.

15 Maintenance



CAUTION

Faulty power cord

Electric shock or damage to the device

- Check the power cord regularly for damage.

IMPORTANT

Keep the unit and tank clean and dry to prolong its service life. Regularly remove all dirt residues and accumulated dust from the blower.

15.1 Replace the network cable

- ✓ The network cable or plug contacts are visibly damaged.
- Replace damaged network cables immediately.

i NOTE! Removable network cables may not be replaced with insufficiently measured network cables!

- ➔ The network cable has been replaced.

15.2 Clean enclosure

- ✓ The enclosure is dirty.
- ✓ The network cable is unplugged.
- Wipe all surfaces using a damp cloth.

⚠ WARNING! Do not spray the outside of the unit with water.

- ➔ The enclosure has been cleaned.

15.3 Cleaning the tank

- ✓ The tank is full of limescale or dirty.
- ✓ The tank is empty.

1. Use a damp cloth to wipe out limescale and dirt residue. If necessary, rinse the tank using a shower set.

⚠ CAUTION! Do not spray the outside of the unit with water.

- ⇒ The tank has been cleaned.

2. To descale the tank, fill it with tap water up to the fill level marking in the tank.

3. Heat up the unit to 40 °C.

4. Add 4–10% of Elma clean 60 or Elma clean 115C.

5. Once 40 °C has been reached, switch off the unit.

- ⇒ Leave the solution to work for approx. 12 hours.

6. Then, switch on eco ultrasound mode for approx. 15 min.

7. Empty the tank.

8. Use a damp cloth to wipe out the remaining limescale and dirt residue. If necessary, rinse the tank using a shower set.

⚠ CAUTION! Do not spray the outside of the unit with water.

- ➔ The tank has been descaled and cleaned.

15.4 Disinfect

We recommend the following surface disinfectants:

- Incidin Liquid by Ecolab (ready-to-use, quick disinfectant).
- Terralin protect by Schülke.
- ✓ Use the disinfectant in accordance with the manufacturer's instructions.
 - Disinfect the tank and the housing using a commercially available surface disinfectant on a regular basis. **⚠ CAUTION! Test the disinfectant on a small area first to ensure it does not affect the materials, particularly the controls.**
- ➔ The unit is ready for further use.

15.5 Clean the blower and check that it is working correctly (sizes 120 and up)

Dust and dirt adhering to the protective grille of the blower can impair the cooling performance or cause unit malfunctions.

- Regularly remove accumulated dust and dirt.
- ✓ The unit is ready for operation and filled with fluid to enable the functions to be checked.
 1. Heat up the unit to approx. 55 °C.
 2. The blower will start after > 50 °C is reached.
 - ⇒ If the sound of the blower is clearly audible, the blower is working.
 - ⇒ If no sound can be heard from the blower, send the unit for repair immediately.
 3. Switch off the unit.
- ➔ The blower function has been checked.

16 Disposal

CAUTION

Once the unit has reached the end of its service life, ensure that the unit and accessories are disposed of safely and correctly:



- Clean and disinfect the old device and accessories before disposal.
- Do not dispose of old devices with household waste, but instead at the local collection and disposal points.
- Secure the old device against unauthorised access until removal; if necessary, dispose of the power cable separately.
- Observe regionally applicable disposal directives.
- Data protection notice: The end user is responsible for deleting personal and confidential data from the unit being discarded.

List of figures

Illustration 1	Product contents	12
Illustration 2	Operating side	13
Illustration 3	Controls	14
Illustration 4	Drain ball valve 1. open/2. closed	17
Illustration 5	Fill-level marking	17
Illustration 6	Drain ball valve (1. closed/2. open)	23